

PRIMAL

STRENGTH

POSILOVACÍ KLEC PRIMAL STRENGTH V3 HOME RACK S BRADLY A VESLOVACÍM ADAPTÉREM NA OLYMPIJSKOU OSU

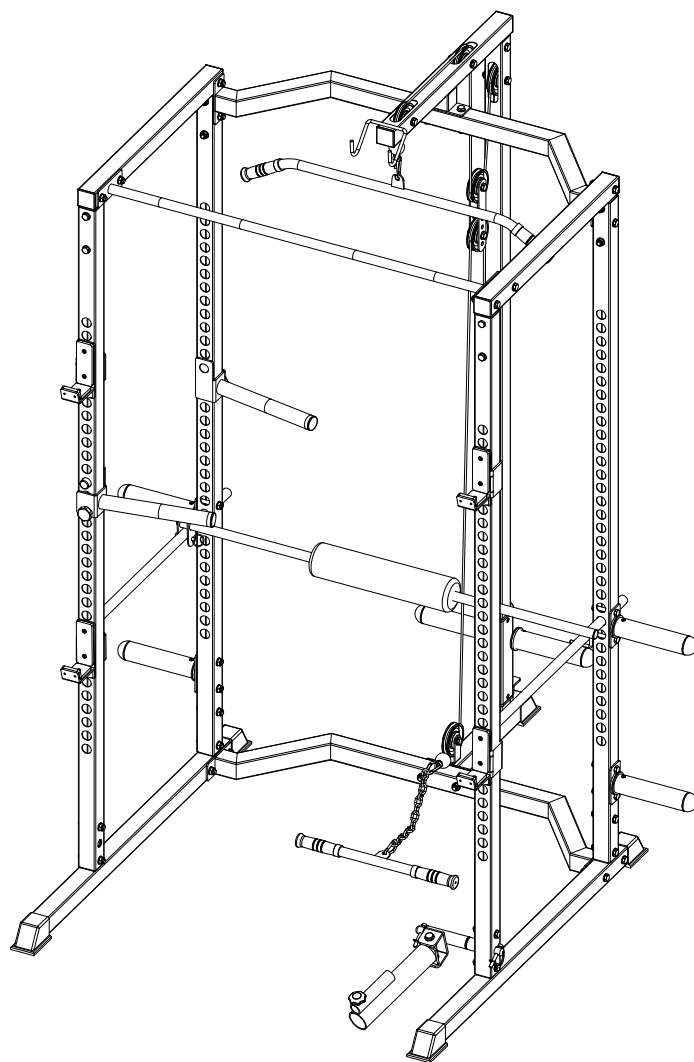





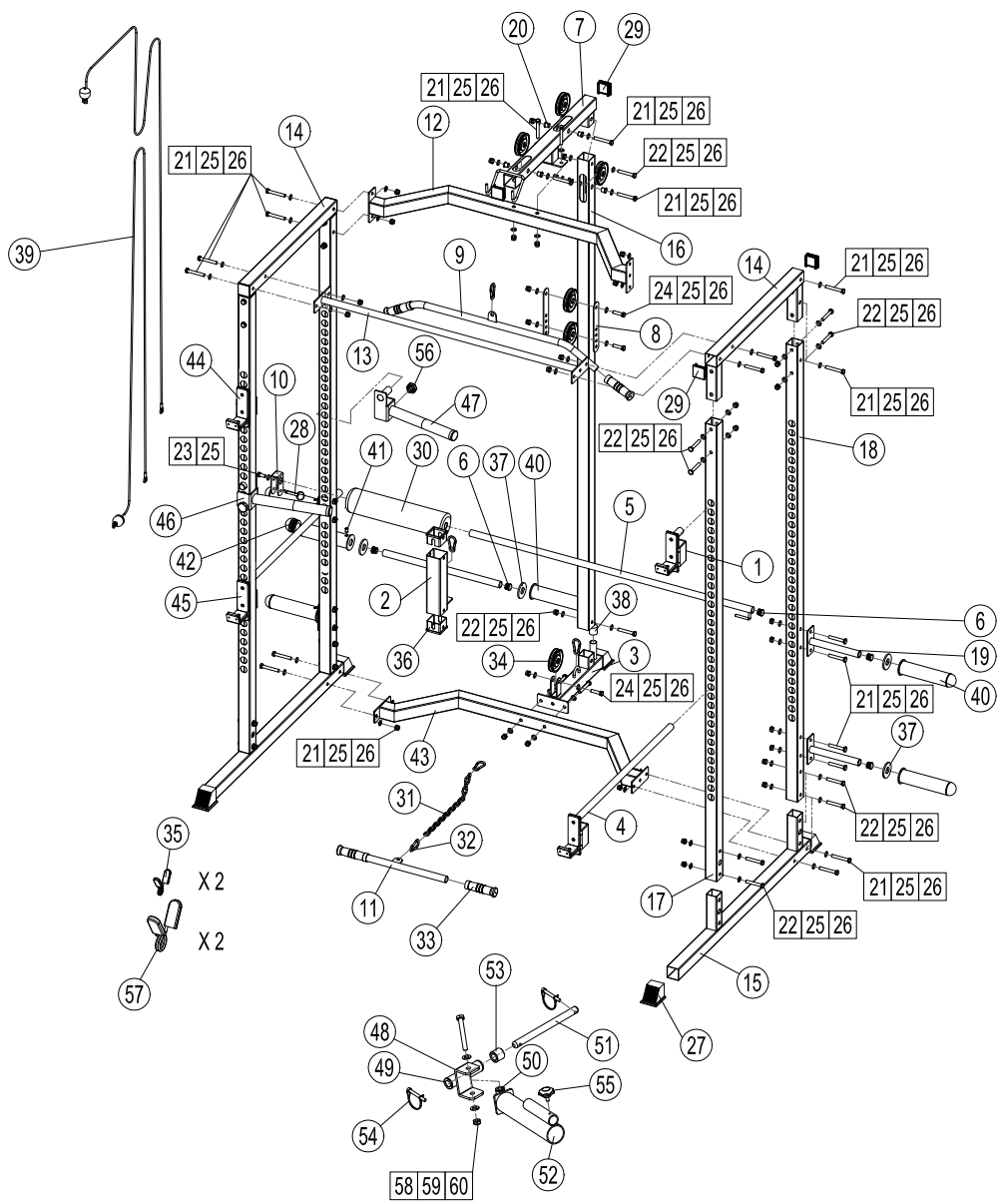



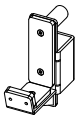
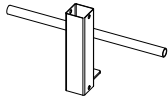
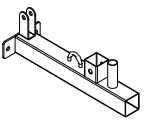
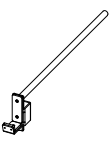
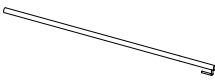

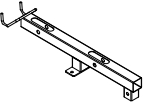
MONTÁŽNÍ POKYNY

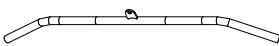
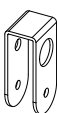

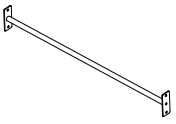

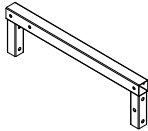
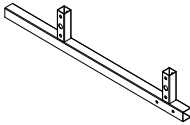
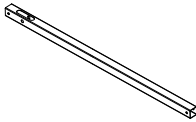
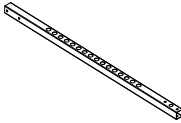
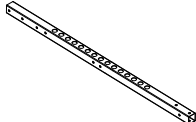
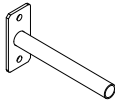

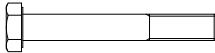
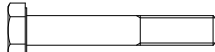
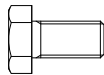
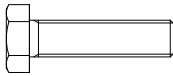
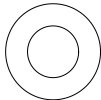
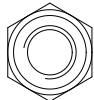

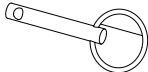

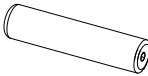
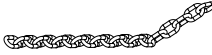

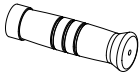
TECHNICKÝ ROZKRES

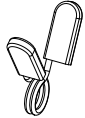



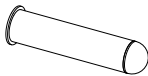



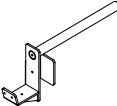

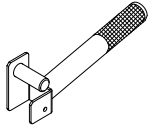
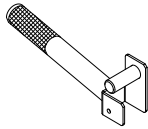

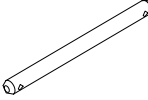
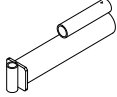

SEZNAM DÍLŮ

ČÍSLO	POPIS		MNOŽSTVÍ
1	LEVÁ KRÁTKÁ BEZPEČNOSTNÍ LIŠTA		1
2	NAKLÁDACÍ TRNY KLADKY NA KOTOUČE		1
3	SPODNÍ NOSNÍK		1
4	LEVÁ DELŠÍ BEZPEČNOSTNÍ LIŠTA		1
5	PODPĚRA PĚNOVÉHO VÁLCE		1
6	ZÁSTRČKA NA TYČ		7
7	HORNÍ NOSNÍK		1
8	SPONA KLADKY		2
9	STAHOVACÍ MADLO		1
10	UPÍNACÍ DESKA		1
11	SPODNÍ TAŽNÁ LIŠTA		1
12	ZADNÍ PŘÍČNÝ NOSNÍK		1
13	CHROMOVÁ LIŠTA NA ZDVIHY		1



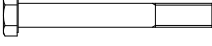

14	HORNÍ PŘÍČNÝ RÁM		2
15	SPODNÍ ZÁKLADNÍ RÁM		2
16	HLAVNÍ RÁM KLADKY		1
17	PŘEDNÍ KOLMÝ RÁM		2
18	ZADNÍ KOLMÝ RÁM		2
19	ODKLÁDACÍ TRN NA KOTOUČE		4
20	VYMEZOVACÍ POUZDRO 16		6
21	ŠROUB M10*70		19
22	ŠROUB M10*65		26
23	ŠROUB M10*20		1
24	ŠROUB M10*40		3
25	PODLOŽKA 10		89
26	POJISTNÁ MATICE M10		48
27	KRYTKA SPODNÍHO RÁMU		5
28	8*35 ZAJIŠŤOVACÍ ŠROUB		1

29	KRYTKA TYČE 50*50		6
30	PĚNOVÝ VÁLEC		1
31	ŘETĚZ 40CM		1
32	SPONA		5
33	25 MADLO		4
34	90 KLADKA		6
35	STANDARDNÍ PRUŽINA 25MM		2
36	PLASTOVÁ OBJÍMKA TRUBKY 60*50		2
37	PODLOŽKA NÁRAZNÍKU		6
38	25 GUMOVÝ KRYT		1
39	LANA 30*80		1
40	ADAPTÉR		6
41	ŠESTIHRANNÝ ŠROUB M10*10		6
42	KULATÁ ZÁSTRČKA		6
43	SPODNÍ ZADNÍ NOSNÍK		1
44	PRAVÁ KRÁTKÁ BEZPEČNOSTNÍ LIŠTA		1
45	PRAVÁ DELŠÍ BEZPEČNOSTNÍ LIŠTA		1

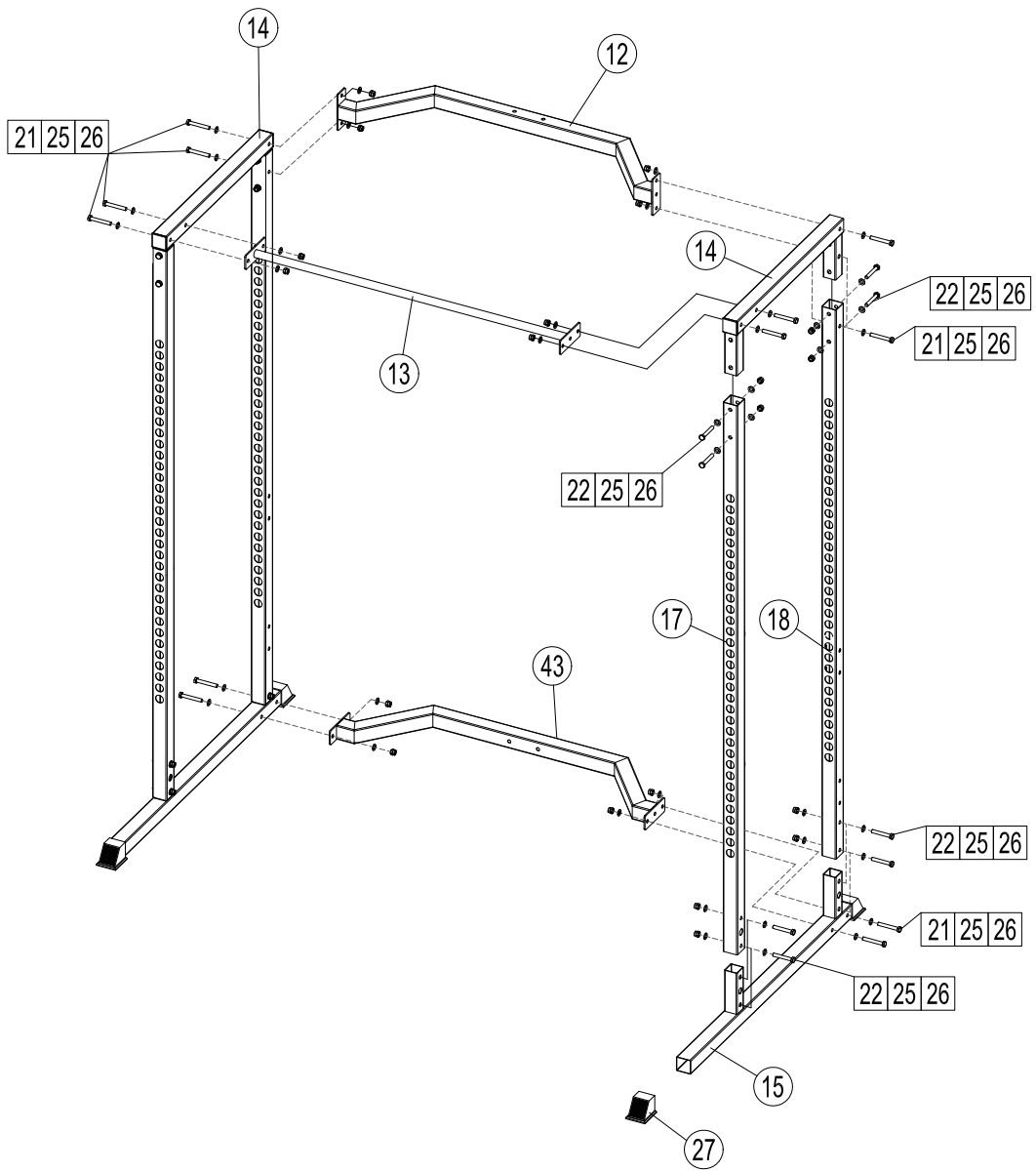
46	PODPĚRA LEVÉHO MADLA		1
47	PODPĚRA PRAVÉHO MADLA		1
48	OTOČNÁ PODPĚRA		1
49	MĚDĚNÉ POUZDRO		2
50	MALÉ MĚDĚNÉ POUZDRO		2
51	OSA		1
52	PODPĚRA TYČE		1
53	NYLONOVÁ PODLOŽKA		1
54	POJISTNÝ KOLÍK		2
55	ŠROUB		1
56	ŠESTIHRANNÝ ŠROUB		2
57	PRUŽINA 55MM		2
58	ŠROUB M12*100		1
59	PODLOŽKA 12		2
60	MATICE M12		1

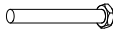



1. KROK

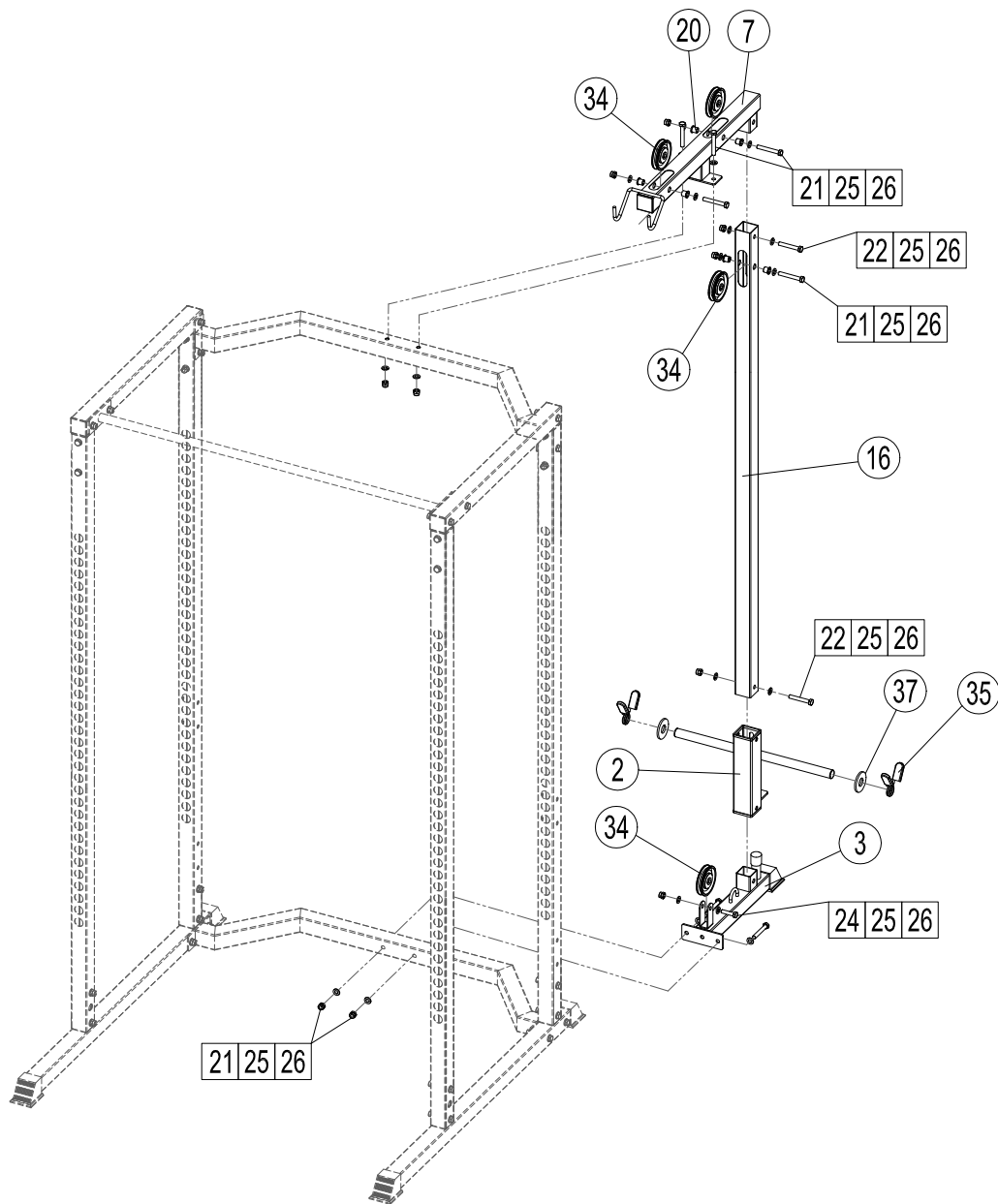

21#		M10*70	Qty:12
22#		M10*65	Qty:16
25#		10	Qty:56
26#		M10	Qty:28

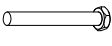
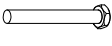

2. KROK



21#		M10*70	Qty:7
22#		M10*65	Qty:2
24#		M10*40	Qty:1
25#		10	Qty:20
26#		M10	Qty:10

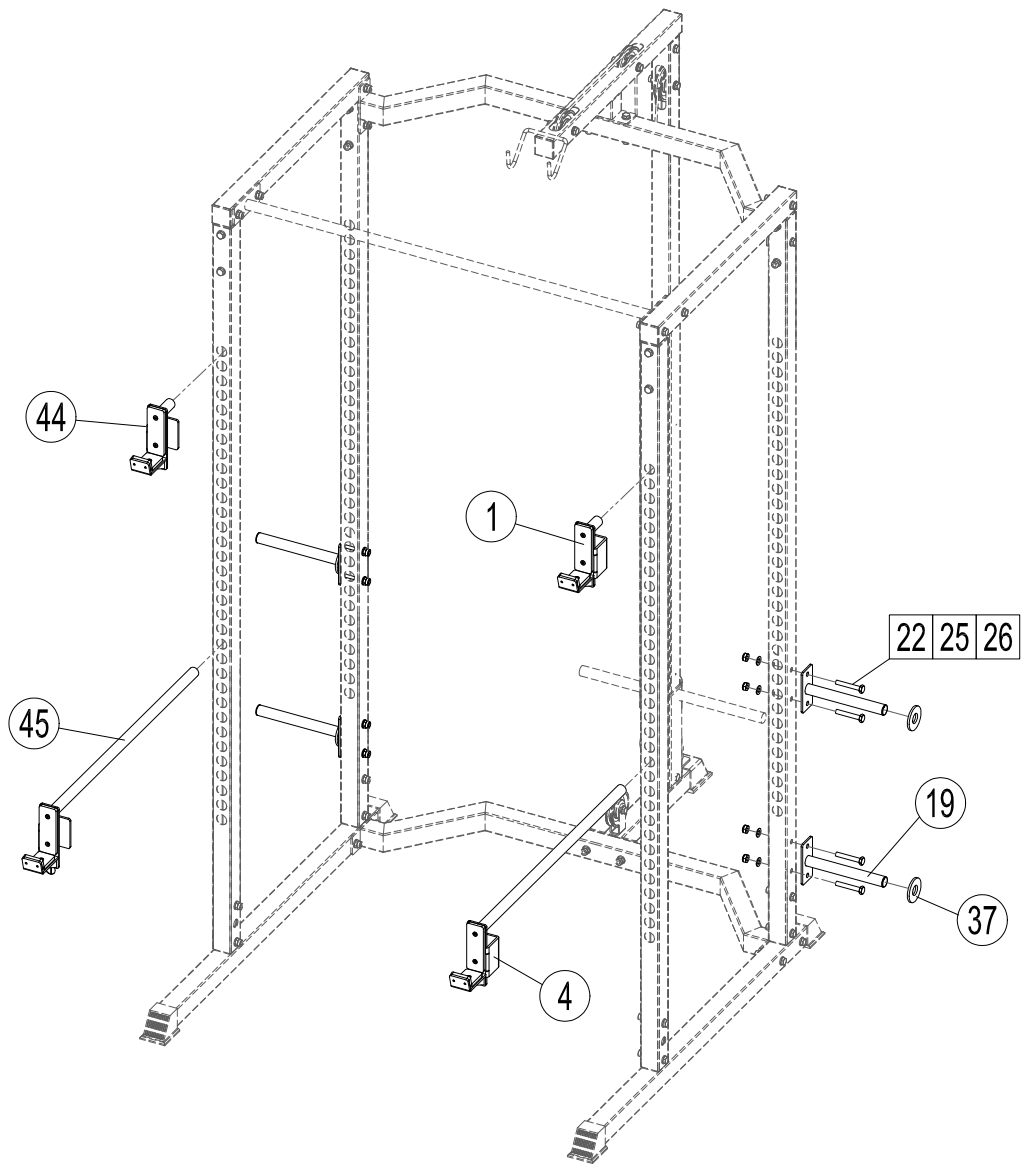

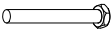

3. KROK



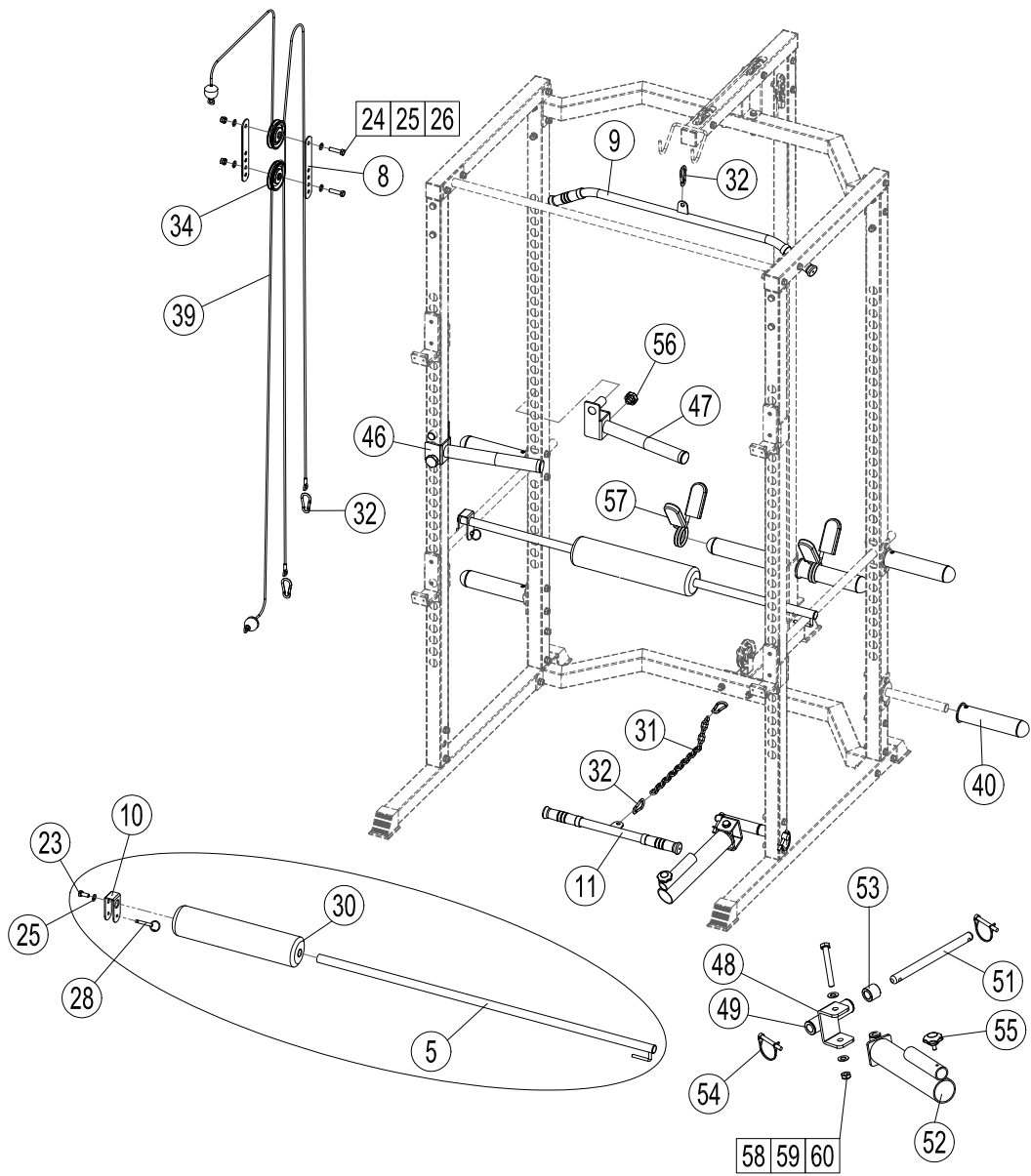

22#		M10*65	Qty:8
25#		10	Qty:8
26#		M10	Qty:8

4. KROK



23#		M10*20	Qty:1
24#		M10*40	Qty:2
25#		10	Qty:5
26#		M10	Qty:2

58#		M12*100	Qty:1
59#		12	Qty:2
60#		M12	Qty:1

5. KROK

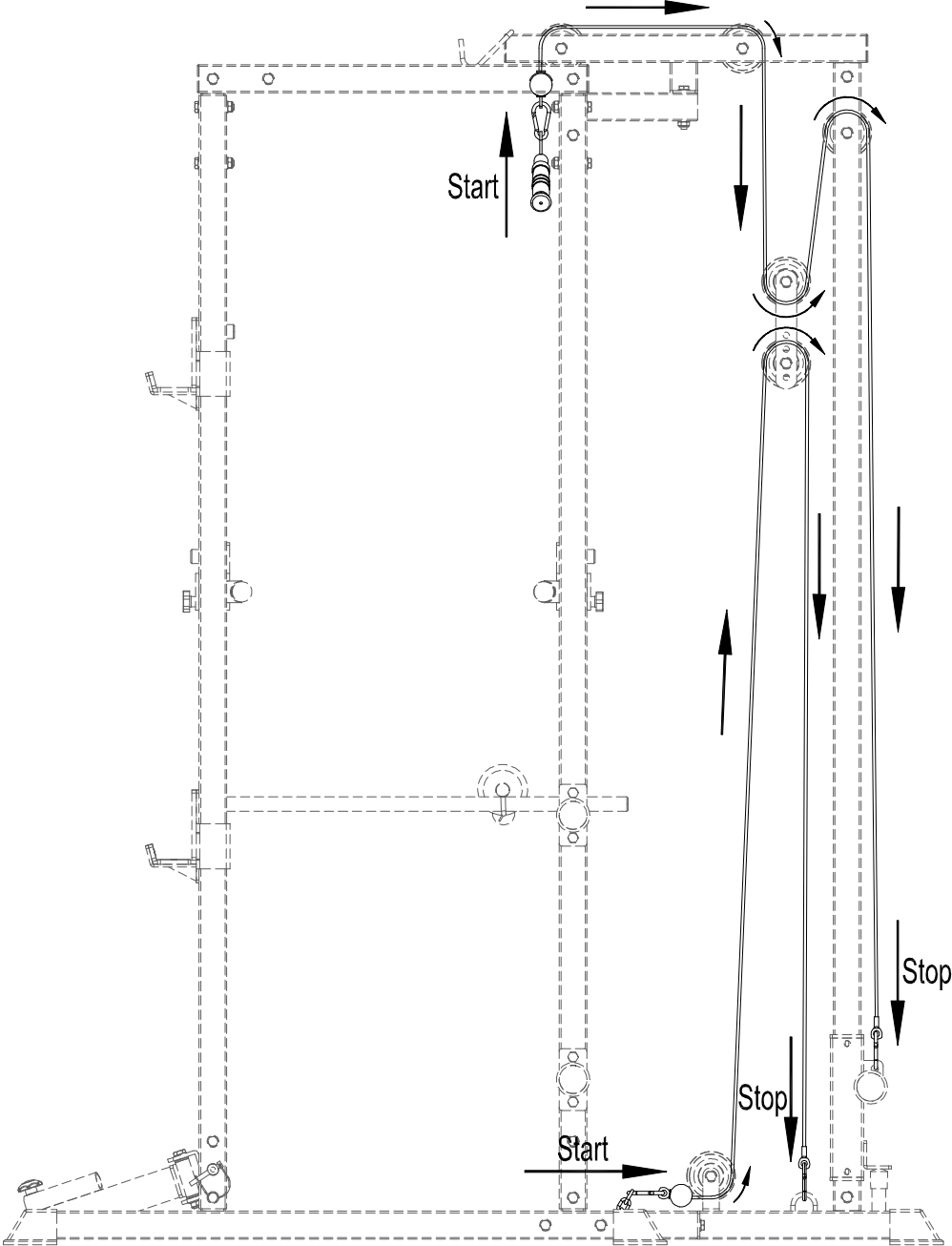

M10*65×26PCS

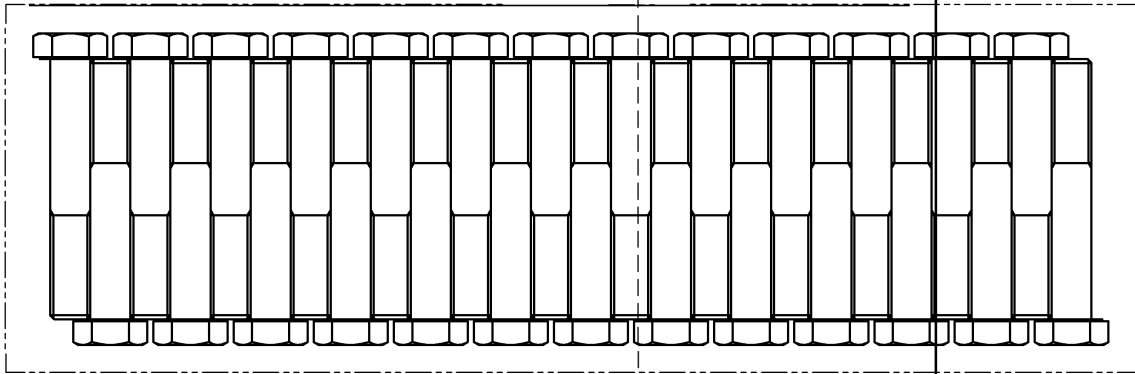

M10*70×19PCS

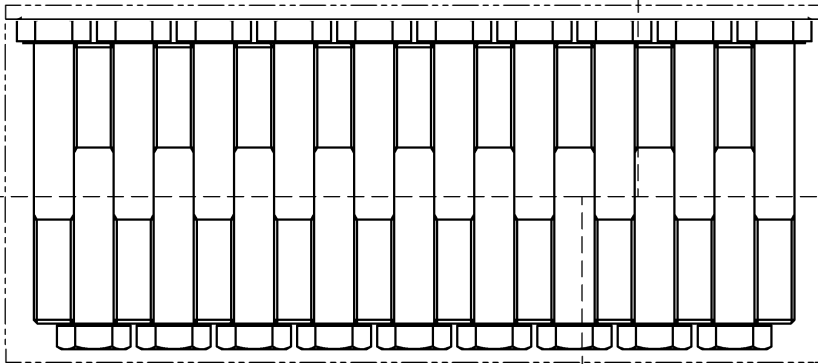

Ø10×89PCS

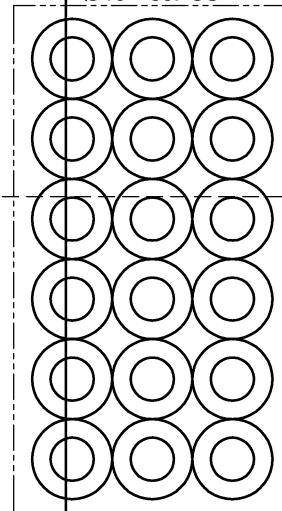

8x35 Locking Bolt : 1PC

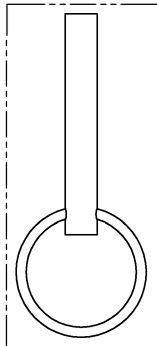

16 Pulley Sleeve: 6PCS

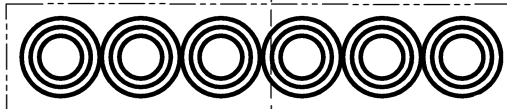

M10*40×3PCS

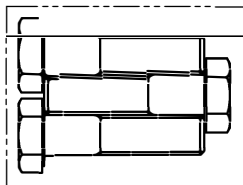

M10*20×1PC

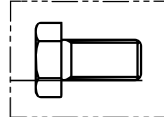

Ø12×2PCS

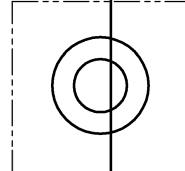

M12×1PC





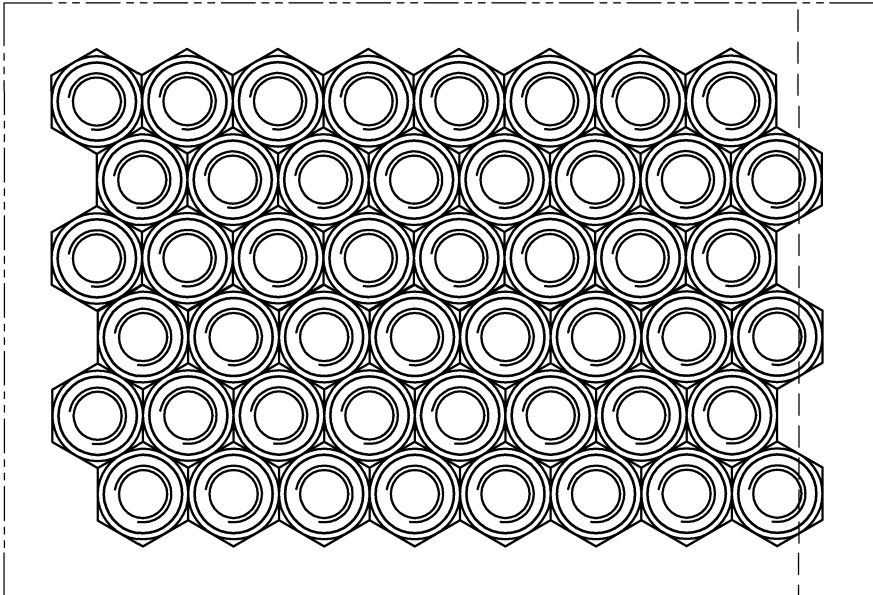



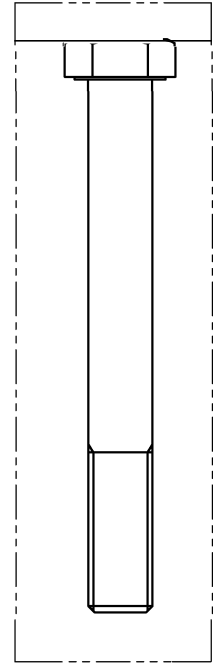







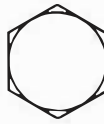



M10×48PCS











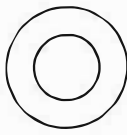
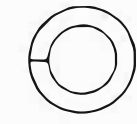

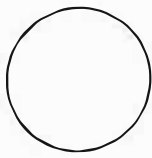
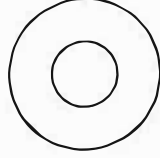
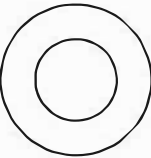
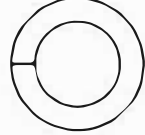
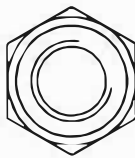

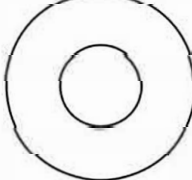
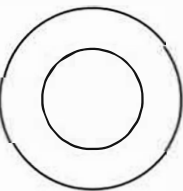
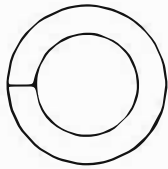
M12*100×1PC

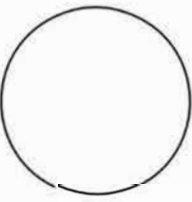
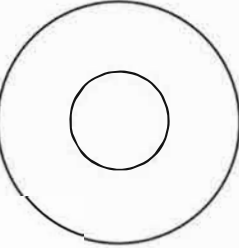

VELIKOSTNÍ TABULKA

					
M8					
M10					
M12					

M8					
M10					
M12					
	Washer 	Spring Washer 	Lock Nut 	Nut Cap 	Big Washer 

Dovozce a distributor pro
Českou a Slovenskou republiku
Trinteco spol. s r.o.
Na Strži 2102/61a,
140 00 Praha 4 – Krč
IČ: 052 54 175
DIČ:CZ05254175



Dovozce a distributor pro Českou a Slovenskou republiku
Trinteco spol. s r.o.
Na Strži 2102/61a, 140 00 Praha 4 – Krč
IČ: 052 54 175 DIČ:CZ05254175

Email: info@trinteco.cz
Telefon: +420 725 552 257